















2018-Present Jeep Wrangler JL (4Dr) Soft Top

xBars fit under factory Soft Top - Carry gear when top Exposed. If running NO Top, add (1) 8-00-9919 Spacers

20363

Level* represent the approximate amount of weight distribution given the crossbars and mounting configuration. Levels are supplied for illustrative purposes only and are examples of how various equipment can be used in conjunction with Exposed Racks. Actual results may vary.

Gear Guide shows how EXR click-in accessories and other mfg. accessories will fit into the crossbar packages. Retail gear, products, sports equipment, and other items are constantly changing and innovating; this guide DOES NOT GUARANTEE fitment of any individual item or combination of items. **Customer/Installer must always refer to Vehicle Owners Manual and follow vehicle weight limits and load capacities.**

PKG Part #	Type/Color	# xBars	Level	Part to Vehicle Fit Notes
8-00-9654-BK	SOLID, BLACK	2 xBars		Top closes over installed racks perfectly. Racks hold gear above the windshield and speaker housing. ; xBars also fit Hard Top configuration; hard top brackets sold separately: (2) 8-00-9791
8-00-9754-BK	CLICK-IN, BLACK	2 xBars		Top closes over installed racks perfectly. Racks hold gear above the windshield and speaker housing. ; xBars also fit Hard Top configuration; hard top brackets sold separately: (2) 8-00-9791
8-00-9754-RD	CLICK-IN, RED	2 xBars		Top closes over installed racks perfectly. Racks hold gear above the windshield and speaker housing. ; xBars also fit Hard Top configuration; hard top brackets sold separately: (2) 8-00-9791
				
				
				
				
				
				
				
				
				
				
				

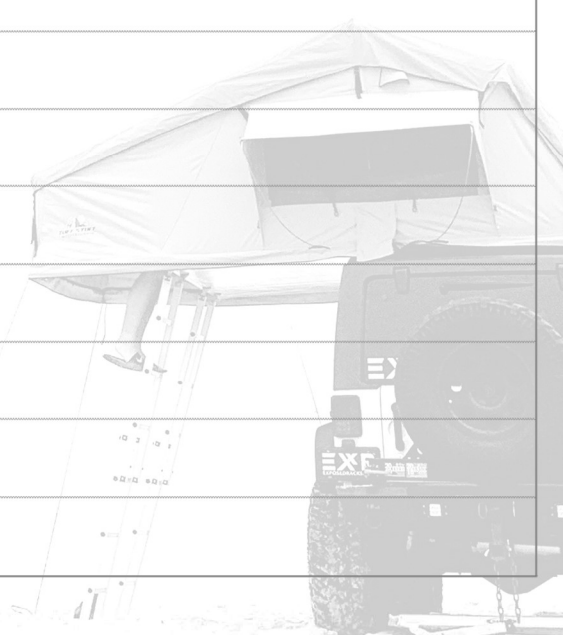

SMS Auto Parts Co., 225 Lincoln Hwy, Fairless Hills, PA 19030 exposedracks.com 215.310.1917 support@smsparts.com

LEVEL GUIDE - some examples of items used within the respective level. NOTE: THIS IS NOT A FITMENT GUIDE. See GearGuide below to figure out click-in accessories.

- A 2 Kayaks | 2 SUP | 4 Surfboards | 6 skis/snow boards | Cargo Basket | Cargo Box | Rods / Paddles | Or other similar items
- B 3 Large Kayaks | 3 SUP | 4 Surfboards | 6 skis/snow boards | Cargo Basket | Cargo Box | Offroad Tire | Container Bins | Medium Cooler | Canoe | other items
- C 2-3 Person Tent (RTT) | Large Canoe | Large Bins | Container Bins | Lots of boards / skis / gear
- D 4-5 Person Tent (RTT) | Large Canoe | Tent + Kayaks | Large Bins | Container Bins | Even more boards / skis / gear | Overlanding Gear
- E Same as 'D' but with more fitment and configuration options

Customer/Installer must always refer to Vehicle Owners Manual and follow vehicle weight limits and load capacities.

GEAR GUIDE - Information below

Crossbars come in various sizes and have different hole patterns. Depending on the size and hole pattern of the bars in the package, installer can use a variety of different click-in accessories. Exposed Racks can be used in many different configurations to help you carry a variety of equipment. We can't list every possibility but we have provided some examples of common gear and equipment for your consideration in your purchase of our products.

DEFINITIONS	
SOLID	Heavy Duty Electroplated and Powdercoated BLACK Steel Tubing (No Square holes for Click-In Accessories). Contains threaded holes for Weight Dist. Feet and accepts most other mfg. accessories
M/F BLACK	Heavy Duty Electroplated and Powdercoated BLACK Steel Tubing (WITH Square holes for Click-In Accessories). Contains threaded holes for Weight Dist. Feet and accepts EXR and other mfg. accessories
M/F RED	Heavy Duty Electroplated and Powdercoated RED Steel Tubing (WITH Square holes for Click-In Accessories). Contains threaded holes for Weight Dist. Feet and accepts EXR and other mfg. accessories
CLICK-IN	Synonymous with "Multi-Function" - used by SMS Auto Parts, Co. to describe crossbars and accessories that Click-In or otherwise very easily assemble and disassemble
WDIST. FT	Weight Distribution Feet - threaded feet that thread into the crossbar, then lower down to the vehicle top to distribute the weight of the carrying load. Feet have a tilting pad and reverse jamb nut
PKG	Complete Crossbar Package or Accessory sold as one Part (One to multiple Vehicle(s) Specific)
ITEM	A Component of a Package sold individually (Universal)
2+	The "+" in the quantity crossbars field indicates the number of crossbars PLUS weight distribution feet. e.g. 2+, 3+, 4+, 5+

*SMS makes no representation or warranty as to the amount of weight that can be safely loaded onto the Exposed Racks for use with your vehicle. The weight and location of the Exposed Racks and any items or material placed upon them may affect your vehicle's safety, handling, stability and performance and may create an increase risk of accident or rollover. The use of Exposed Racks may adversely impact the performance characteristics of your vehicle. Consumers are solely and completely responsible for evaluating their vehicle to ensure that the vehicle, and each part of that vehicle, is appropriate for use of the Exposed Racks and for any gear, item and/or load that you may wish to use in conjunction with the Exposed Racks. Before installing the Exposed Racks and placing any item or load upon them, check and confirm your vehicle's factory recommendations and specifications. The load you are carrying and plus the weight of the rack must not exceed the maximum weight limitations of the vehicle's factory recommendations. Exposed Racks are sold with a LIMITED WARRANTY. See website for details. smsparts.com/warranty.

The applications of Exposed Racks crossbars are virtually unlimited. Given the variety of gear and equipment with which these racks may be used, it is impossible for us to give advice on the suitability of our products to a specific application. You are responsible for determining the suitability of our products to your particular application, and that you are installing and using our products in compliance with all local, state, and federal laws and regulations and applicable health and safety standards. All information is published in good faith and for general information purposes only. SMS does not make any warranties about the completeness, reliability and accuracy of this information. All manufacturer names, symbols, and descriptions, used in our images and text are used solely for identification purposes only. It is neither inferred nor implied that any item sold by SMS is a product authorized by or in any way connected with any vehicle manufacturers displayed on this page.

